



## FREE STANDING CONTACTLESS BOTTLE FILLER

### Installation Instructions For:

#### UNFILTERED

PCPEBF

PCP10EBF

PCPEBFY (230V)

PCP10EBFY (230V)

#### FILTERED

PFCP10EBF

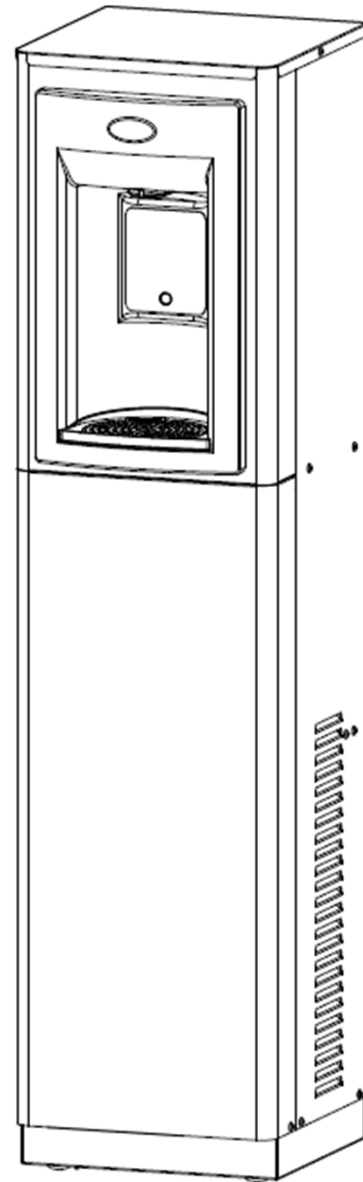

**OASIS International**  
222 East Campus View Blvd.  
Columbus, OH 43235  
614-861-1350  
[www.oasiscoolers.com](http://www.oasiscoolers.com)

# INDEX

1. PRODUCT SPECIFICATIONS
2. IMPORTANT REQUIREMENTS
3. SAFETY WARNINGS
4. GETTING STARTED
5. PROPER QUICK CONNECT FITTING CONNECTION INSTRUCTIONS
6. INSTALLATION
7. SET-UP GUIDE FOR DISPENSER PCB ELECTRONICS

## 1. PRODUCT SPECIFICATIONS

### **Dimensions:**

Depth 13.35”(339.0 mm)

Width 12” (304.8 mm)

Height 49.7” (1262.4 mm)

**Refrigerant:** R-134a

**Input Voltage:** 115 VAC, 60 HZ or 220/240 VAC, 50/60HZ –See Data Plate

## ROUGHING-IN AND DIMENSIONAL DRAWING

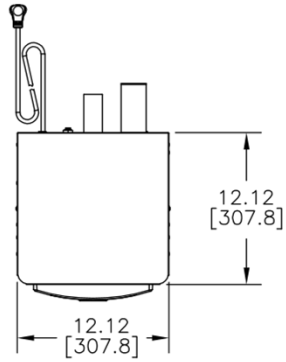

ALL DIMENSIONS ARE IN INCHES.

DIMENSIONS IN BRACKETS [ ] ARE IN MILLIMETERS.

ALLOW 4" [102] FOR VENTILATION AT THE REAR OF THE WATER COOLER AND THE SIDES IF SET IN AN ALCOVE OR NEAR A CORNER.

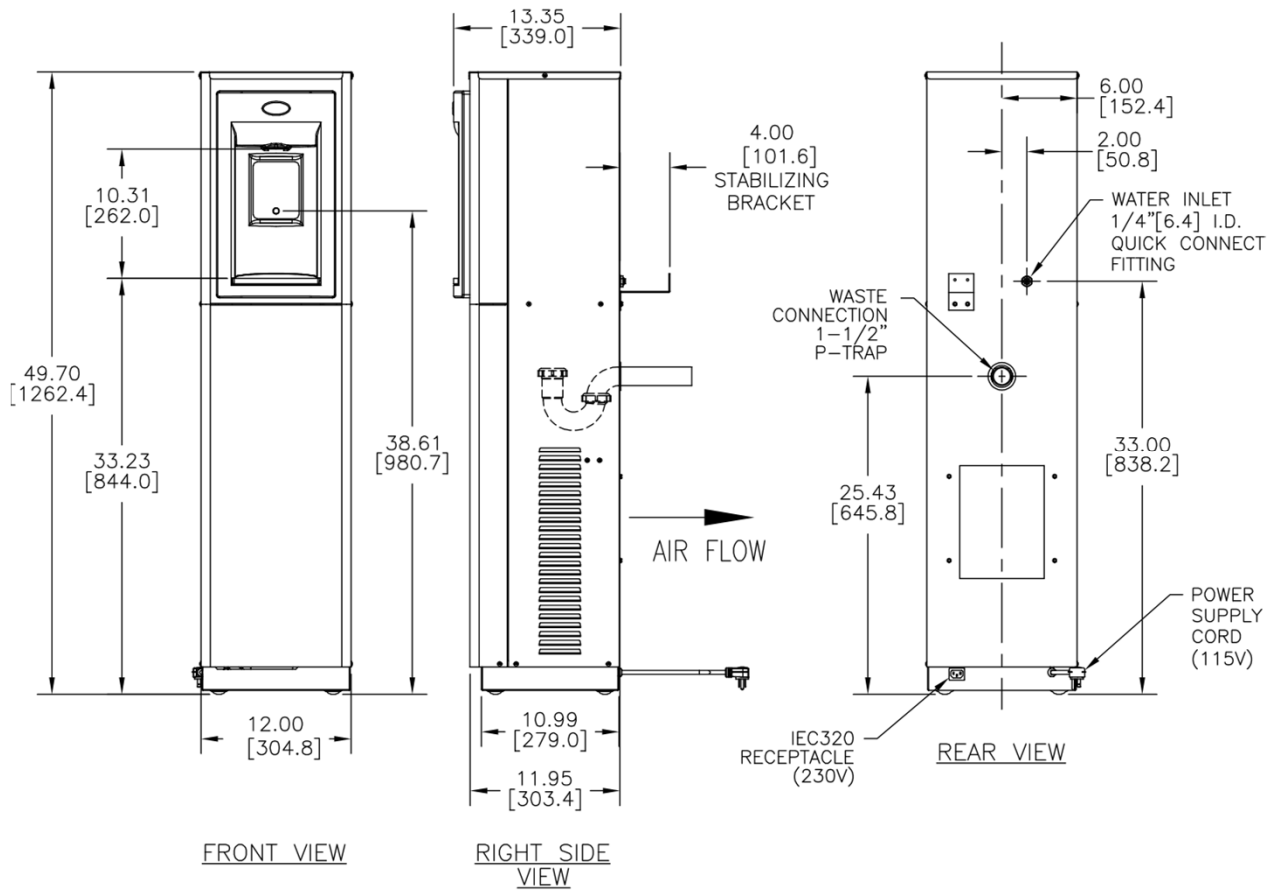

## 2. IMPORTANT REQUIREMENTS

- Use only original and new parts to guarantee the reliability, optimization, and performance of the OASIS water machine.
- Always wear proper protection when performing any type of service or maintenance.
- When cleaning the unit, do not use corrosive acidic products, or metal brushes.
- Do not wash the unit using high-pressure water.
- Connect to a water supply with a pressure of 45 PSI minimum to 100 PSI maximum (3.10 bar minimum to 6.89 bar maximum ).
- **WARNING:** DO NOT USE WITH WATER THAT IS MICROBIOLOGICALLY UNSAFE OF UNKNOWN QUALITY.
- **ATTENTION:** IT IS IMPORTANT TO MAKE PROPER CONNECTIONS TO THE QUICK CONNECT FITTINGS TO AVOID LEAKS. **SEE SECTION 5.**
- **CAUTION:** DO NOT PLACE UNDUE STRESS OR SIDE LOAD ON ANY OF THE PLASTIC FITTINGS.

## 3. SAFETY WARNINGS:

**BEFORE YOU START USING THIS WATER DISPENSER, PLEASE READ THE FOLLOWING INSTRUCTIONS CAREFULLY.**

- The unit must be connected to a 115 VAC GFCI or 230VAC power supply as listed on the equipment data label.
- The unit must be protected by a properly installed 20 amp circuit breaker. Verify that the electrical current is correct for the power of this unit, which is listed on the machine data label.
- To avoid electrical shock always unplug the unit from the electrical outlet before servicing.
- If the power supply cord is damaged, it must be replaced by a special cord or assembly available from the manufacturer or its service agent.
- This appliance must be earthed.
- Children should be supervised to ensure that they do not play with this appliance.

## 4. GETTING STARTED:

### What's Included:

- a. CONTACTLESS BOTTLE FILLER
- b. STABILIZER BRACKET
- c. OPTIONAL VERSAFILTER III

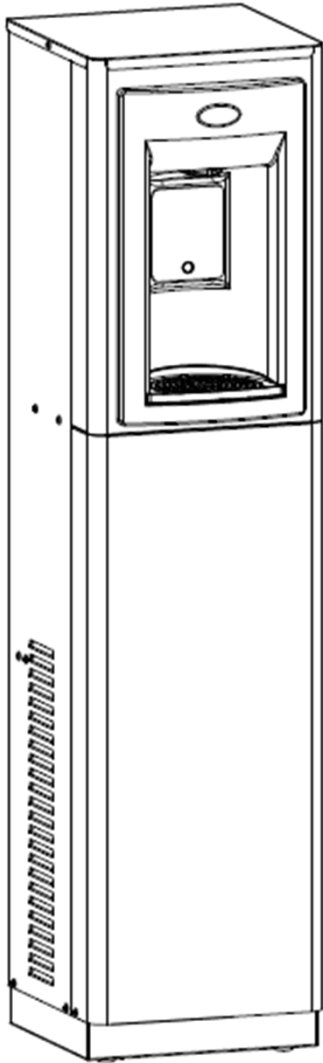

CONTACTLESS  
BOTTLE FILLER

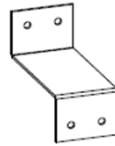

STABILIZER BRACKET

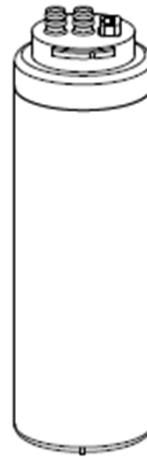

VERSAFILTER III  
(Filtered models only)

## 5. PROPER QUICK CONNECT FITTING CONNECTION INSTRUCTIONS:

### Quick-Connect Fittings

- If you need to cut the plastic tubing, be sure to cut tube ends square and straight. Do not deform the tube (i.e., cause tube to compress its diameter so it is no longer round, or it may result in a water leak at the fitting).
- Make sure the outer surface of the tube is clear of marks or scratches for a length equal to twice the tube diameter. This allows the “O” ring to seat properly against the tube (See figure below).
- Avoid sharp changes in direction when routing the tubing. Sharp turns could cause the tubing to kink, which reduces its flow capacity and or stops it completely.
- Fittings consist of two parts: a body and a collet. (See figure below).
- To install a tube, push it through the collet until it seats firmly at the bottom of the fitting.
- To remove a tube, push and hold the collet against the body while pulling the tube out. Pushing the tube into the body before pushing the collet in will aid in the removal of the tube.

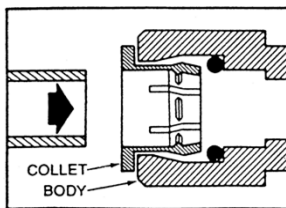

Push tube through  
Collet into Body

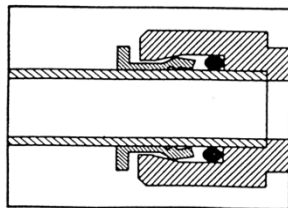

Tube must seat firmly  
At bottom of fitting

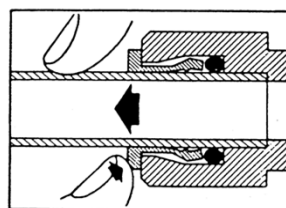

Push Collet against  
Body to release tube

## 6. INSTALLATION:

### **STEP 1 & 2:**

1. Carefully unpack Water Dispenser and remove filter from the alcove (filtered models only).
2. Remove Front Panel by removing the 2 screws at the bottom of the panel on the sides. **See Diagram 1 and 2.**

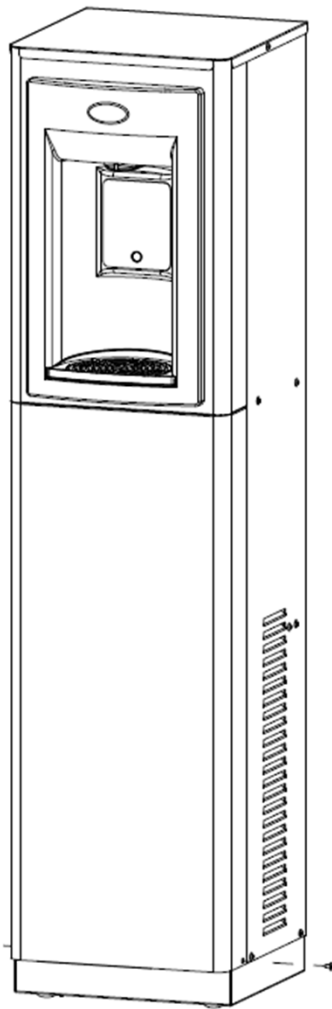

DIAGRAM 1

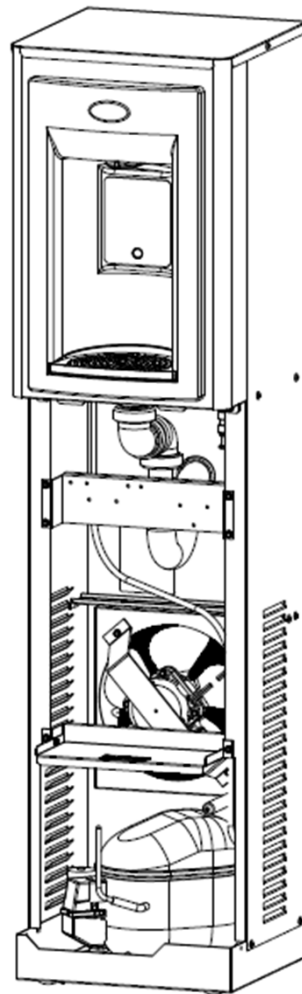

DIAGRAM 2

REMOVE  
T15 TORX SCREWS  
QTY. 2

## 6. INSTALLATION:

### **STEPS 3 through 5 (for optional filters)**

Note: The VersaFilter III was placed in the alcove on the front of the cooler for shipping.

3. Unpack the VersaFilter III and remove the sanitary cap.
4. Looking at the filter top, orient the filter so that the rectangular lug, on top of the filter faces forward.
5. Push the filter up into the filter housing and rotate the filter one-quarter turn to the right until it stops turning. Refer to Diagram 3

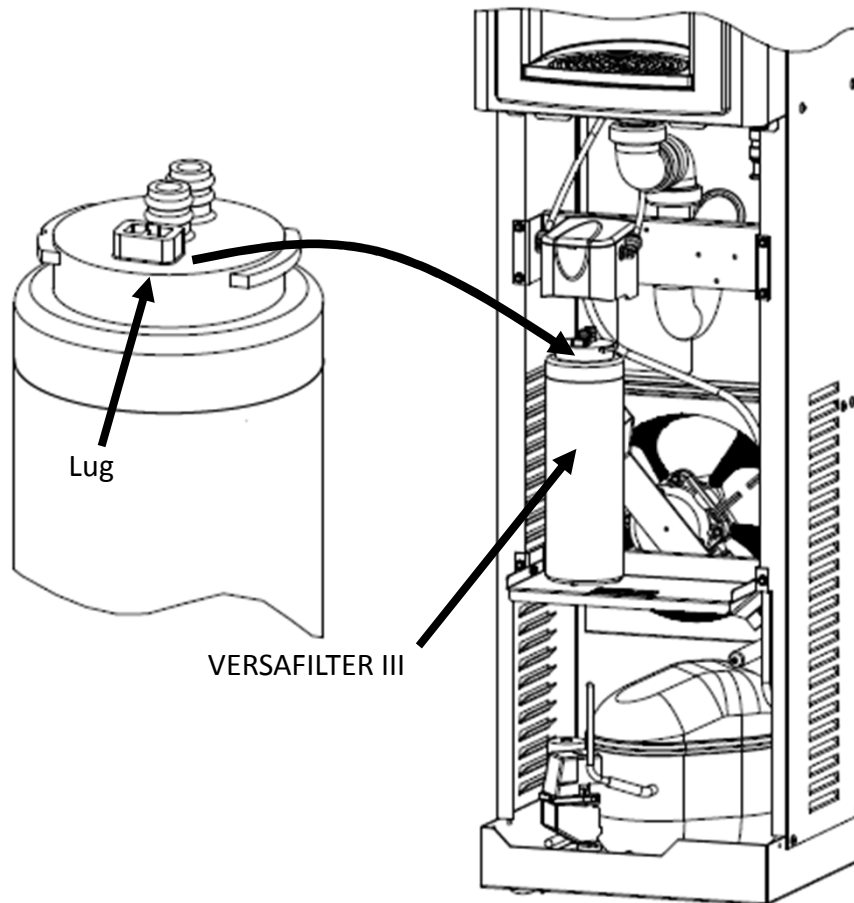

DIAGRAM 3



## 6. INSTALLATION:

### **STEP 6:**

6. Locate the Snap Bushing in the back of the cabinet and feed 1-1/2" OD Drain Pipe through the hole. See Diagram 4 & 5.

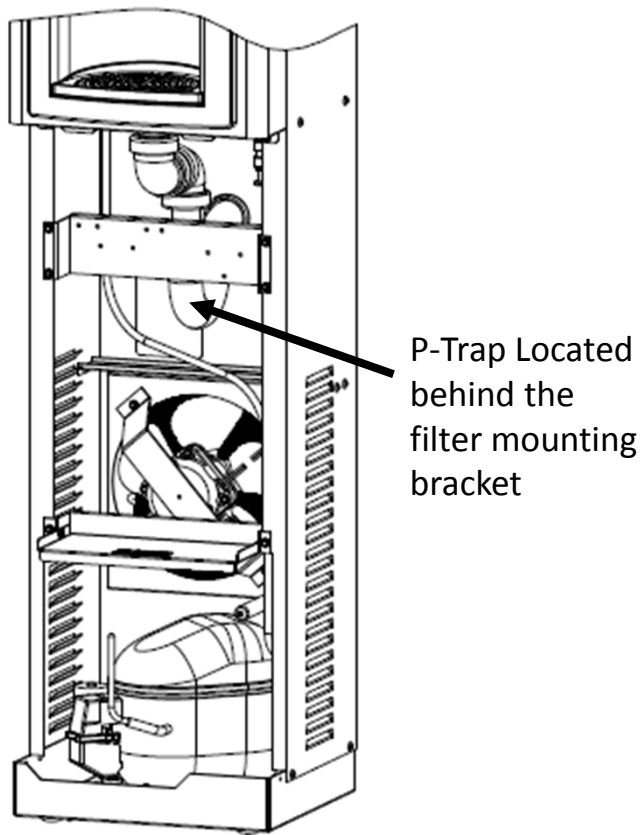

DIAGRAM 4  
Front View

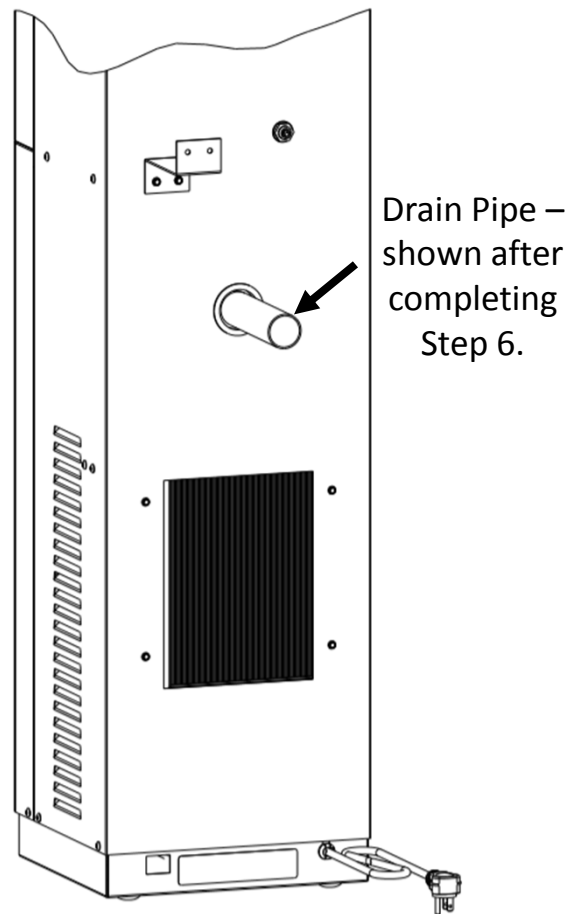

DIAGRAM 5  
Rear View

## 6. INSTALLATION:

### STEPS 7 through 9:

7. Connecting 1/4" OD water supply tube to 1/4" quick connect fitting on the back of the unit. Refer to Section 5 for instructions on how to properly connect to quick connect fittings. **IMPORTANT:** Before connecting water supply to dispenser, **flush building water supply.**
8. Connect 1-1/2" OD drain pipe to Elbow Coupling (not provided). Connect to building drain.
9. Attach stabilizing bracket to the unit with screws provided. Then secure the bracket to the wall with wall anchors provided by others.

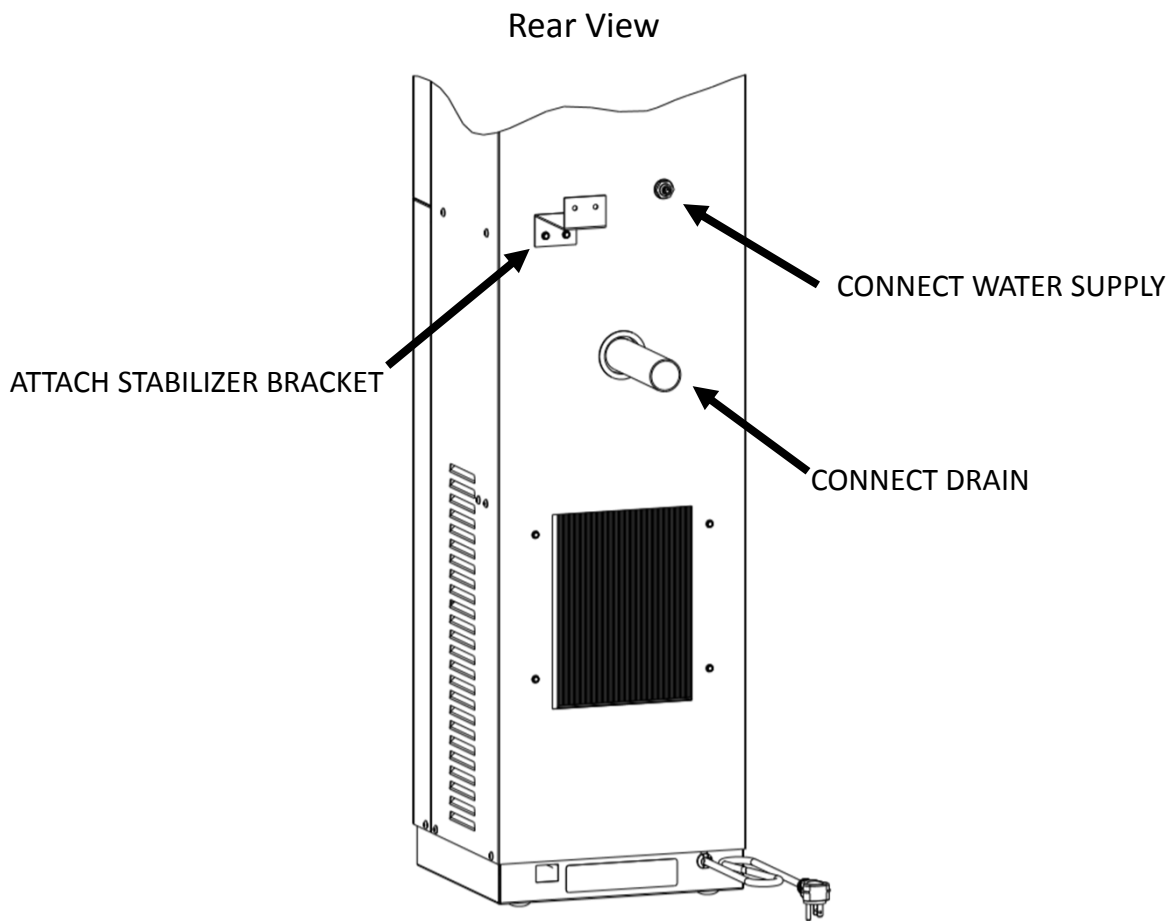

Diagram 6

## 6. INSTALLATION:

### **STEPS 10 through 17:**

10. **ENERGIZING UNIT:** Check the available power supply against the water dispenser data plate to assure correct electrical service. This water dispenser is intended to be connected to a 20A minimum ground fault circuit interrupting (GFCI) device to meet UL requirements. Plug Power Supply Cord into outlet.
11. **DISPENSING/FLUSHING FILTERS (OPTIONAL)**
  - Place a container in the alcove to activate water dispense. The flow of water will be delayed until the filter fills with water.
  - Flush water through the system until the water becomes clear.
12. Check system for any leaks.
13. Rotate the fan blade to see that it is free of obstructions.
14. Place bottle in alcove to purge additional air in Cooling Tank and water lines. The Water Dispenser sensor will run for 20 seconds and shut-off. Do this 2 or 3 times until a steady stream of water dispenses.
15. **SETTING UP PCB ELECTRONICS:** Follow instructions in **Section 7** to change default settings.
16. Re-install Front Panel, and 2 screws.
17. Set up is complete. Enjoy!

## 7. SET-UP GUIDE FOR DISPENSER PCB ELECTRONICS:

### Factory default program settings are:

- Units - Gallons
- Unfiltered unit
- Flow Meter = Rate Selected
- Filter Capacity = 1250 gallons [4731 liters]
- Bottle Count = 0.5L (1 Bottle)
- Flow Rate = 1.2 GPM
- 20 second maximum dispense time

Top panel will need to be removed by taking out the two screws on each side. Set aside until programming is complete. Remove wire tie bundling pushbutton inside bottle dispenser. You can then adjust program using the pushbutton through the top of the dispenser.

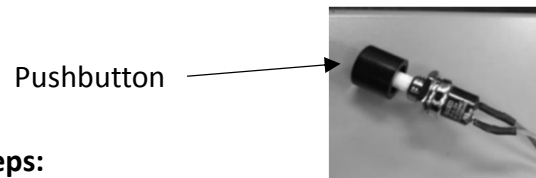

### To change the program settings, follow these steps:

<i>Display</i>	<i>Action</i>
00000000 BOTTLES REUSED (Home Screen)	Depress button for 3 seconds to enter into the following menu settings and make changes. Note: at anytime it will exit menu and save settings when idle for 10 seconds (no button press) and revert back to Home Screen.
LTR/GAL GAL	Depress button 3 seconds to change from Gallons to Liters, or momentary press to advance to next menu.
UNFILT/FILT? UNFILT UNIT	Depress button 3 seconds to change from Unfiltered to Filtered unit, or momentary press to advance to next menu.
FLOW METER? RATE SELECTED	Depress button 3 seconds to change from Rate Selected to (Flow) Meter Enabled, or momentary press to advance to next menu.
SELECT RATE 1.2 GPM UNIT	To change flow rate, momentarily depress button to change whole gallon digit. Hold button 3 seconds to advance to TENTHS of gallon digit. Depress momentarily to change the digit. Hold button 3 seconds to advance to the next menu.
RESET 00000000 GALLON CNT [LTR COUNT]	Depress button for 3 seconds to reset Gallon or Liter count, or momentary press to advance to next menu.
FILT CAPAC OF 1250 GAL [4731 LTR]	Depress button for 3 seconds to change filter capacity to 3000 GAL [11355 liters] for Galaxi green filter, or momentary press to advance to next menu.
3 sec rule? 0.5L	Depress button for 3 seconds to switch from 0.5L bottle to 3 sec rule, or momentary press to advance to next menu. (The 3 Sec rule increases the bottle count based on a 3 second dispense.)
Reset 00000000 BOT COUNT?	Depress button for 3 seconds to reset (Home Screen) BOTTLES REUSED count, or momentary press to advance to next menu.
Bot Filler Set_time: 20 s	Depress button for 3 seconds to change maximum dispense time to 10, 20 or 30 seconds, or momentary press to advance to next menu.
RUN CAL AGAIN?	Depress button 3 seconds to run calibration again, or momentary press to advance to next menu.